

## Single Phase 6.0Amp Glass passivated Bridge Rectifiers

### Features

- The plastic package carries Underwriters Laboratory Flammability Classification 94V-0
- Idea for printed circuit board
- Glass passivated junction chip
- Low reverse leakage
- High forward surge current capability
- High temperature soldering guaranteed 260°C/10 seconds at terminals

### Mechanical Data

- Case : Molded plastic body
- Terminals : Solder plated, solderable per MIL-STD-750, Method 2026
- Polarity : Polarity symbol marking on body
- Mounting Position : Any

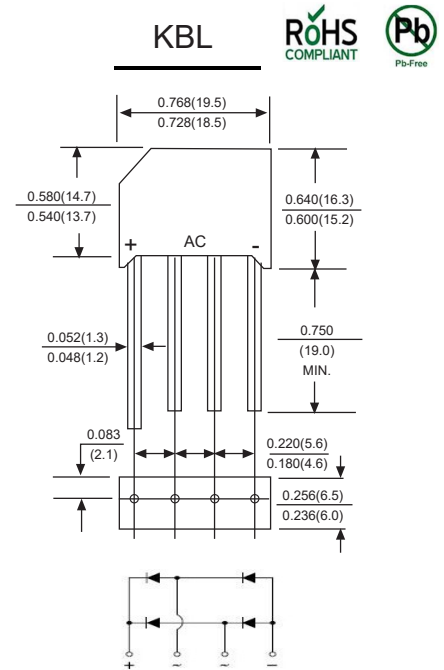

Dimensions in inches and (millimeters)

### Maximum Ratings And Electrical Characteristics

Ratings at 25°C ambient temperature unless otherwise specified. Single phase half-wave 60Hz, resistive or inductive load, for capacitive load current derate by 20%.

Parameter	Symbols	KBL6005	KBL601	KBL602	KBL604	KBL606	KBL608	KBL610	Units
Maximum repetitive peak reverse voltage	$V_{RRM}$	50	100	200	400	600	800	1000	V
Maximum RMS voltage	$V_{RMS}$	35	70	140	280	420	560	700	V
Maximum DC blocking voltage	$V_{DC}$	50	100	200	400	600	800	1000	V
Maximum average forward rectified current with heatsink	$I_{(AV)}$	6.0							A
Peak forward surge current, 8.3ms single half sine-wave superimposed on rated load	$I_{FSM}$	150.0							A
Rating for fusing (t=8.3ms, $T_A=25^\circ\text{C}$ )	$I^2t$	93.3							$\text{A}^2\text{s}$
Maximum instantaneous forward voltage at 6.0A	$V_F$	1.10							V
Maximum DC reverse current $T_A=25^\circ\text{C}$ at rated DC blocking voltage $T_A=100^\circ\text{C}$	$I_R$	5.0 200							$\mu\text{A}$
Typical junction capacitance (Note 1)	$C_J$	45.0							pF
Typical thermal resistance	$R_{qJA}$	55.0							$^\circ\text{C}/\text{W}$
Operating junction and storage temperature range	$T_J, T_{STG}$	-55 to +150							$^\circ\text{C}$

Note: 1. Measured at 1MHz and applied reverse voltage of 4.0V D.C.



Ratings And Characteristic Curves

FIG. 1- DERATING CURVE OUTPUT RECTIFIED CURRENT

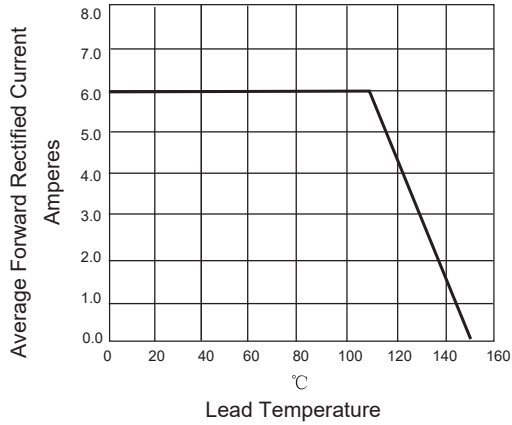

FIG. 2-MAXIMUM NON-REPETITIVE PEAK FORWARD SURGE CURRENT PER LEG

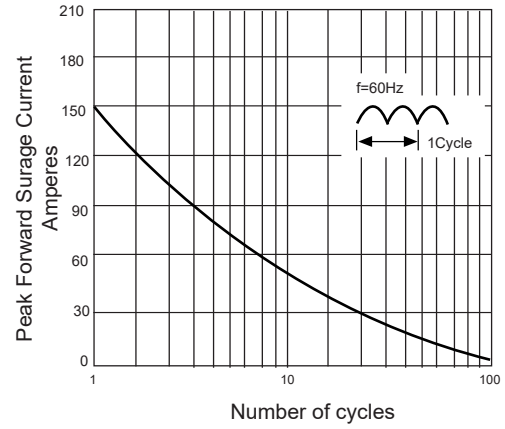

FIG. 3-TYPICAL FORWARD VOLTAGE CHARACTERISTICS

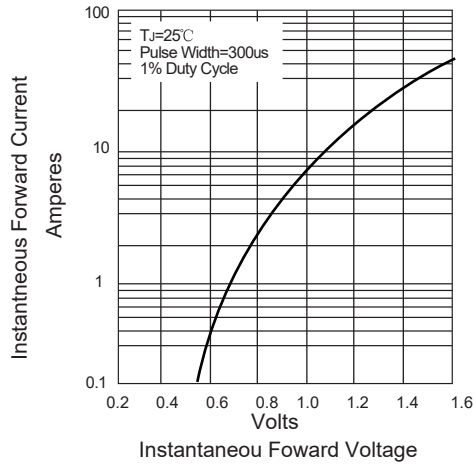
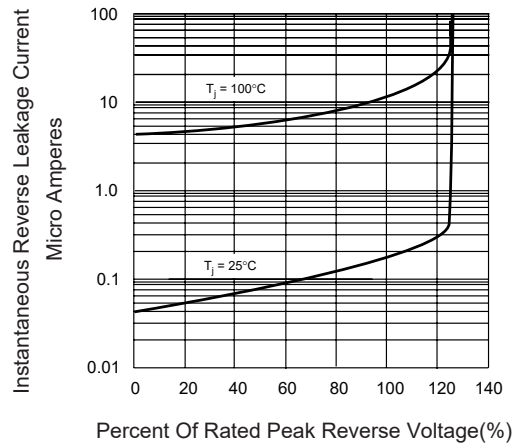
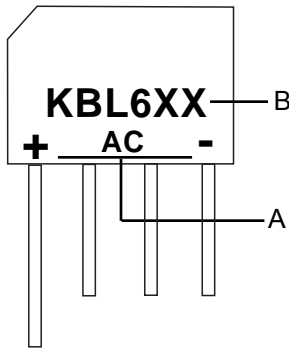

FIG. 4-TYPICAL REVERSE LEAKAGE CHARACTERISTICS





Marking



Symbol	Explanation
A	Polarity Symbol
B	Product Name, X : 005.01.....10

Suggested Soldering Temperature Profile

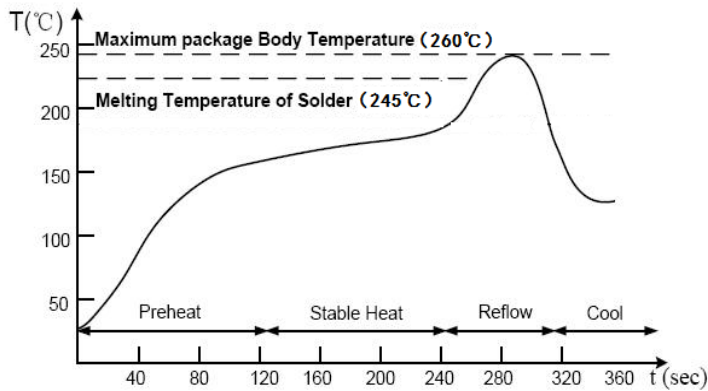

Note

- Recommended reflow methods: IR, vapor phase oven, hot air oven, wave solder.
- The device can be exposed to a maximum temperature of 260°C for 10 seconds.
- Devices can be cleaned using standard industry methods and solvents.
- If reflow temperatures exceed the recommended profile, devices may not meet the performance requirements.